

Installer's Reference

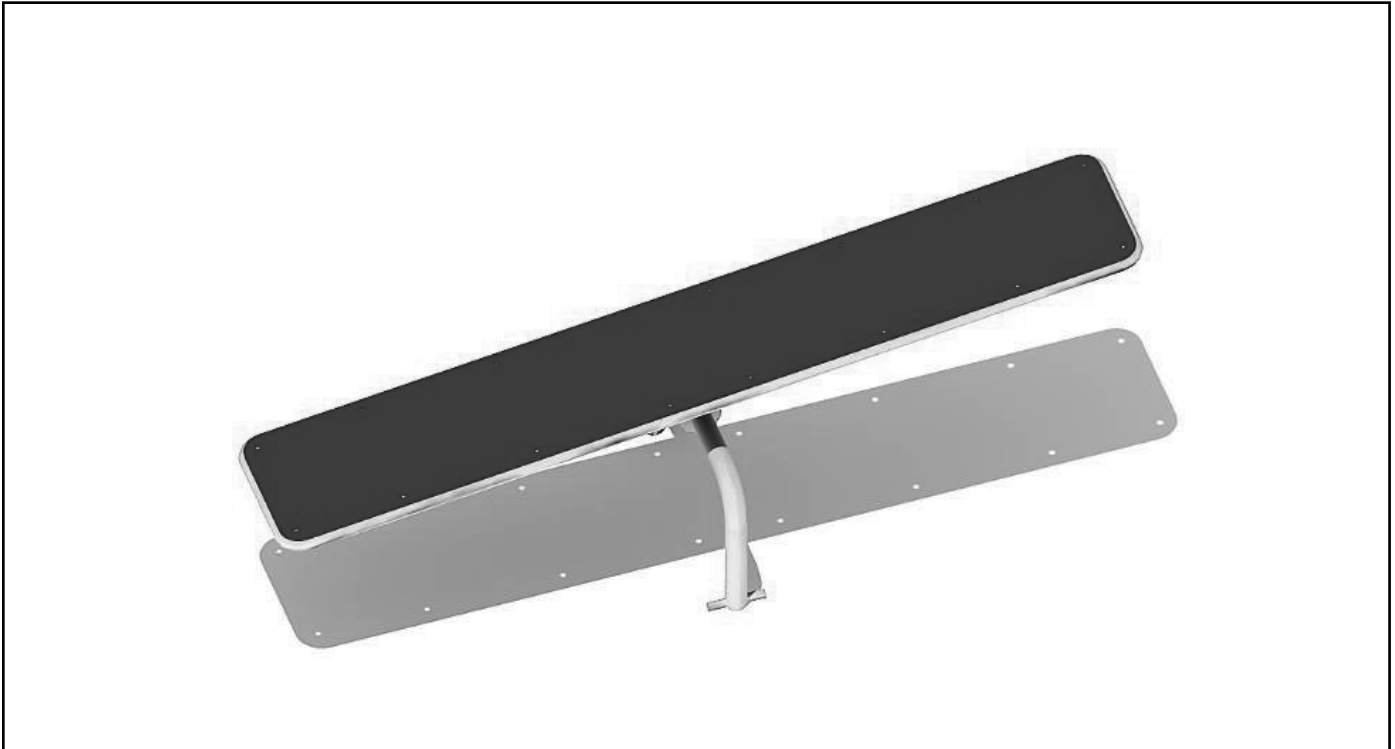

Teeter Totter

Models BAR700130F and BAR700130S

Know What's Below

As with all projects involving digging, start by knowing what is in the ground below. Underground utilities may include cable, electric, sprinklers, sewer, water, telecommunications, drainage pipes and sprinklers. You can usually accomplish this with one phone call (Dial 811) to your state's underground utility service.

Conduct an Inventory

Begin installation with of hardware and parts, assuring everything you need is onsite when you begin.



Barks and Rec
315 Main Street
Eclectic, AL 36024
(866) 826-0131

www.barksandrec.com

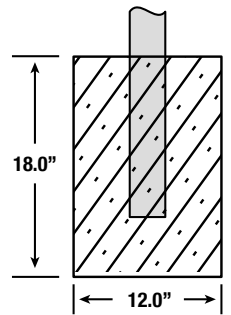
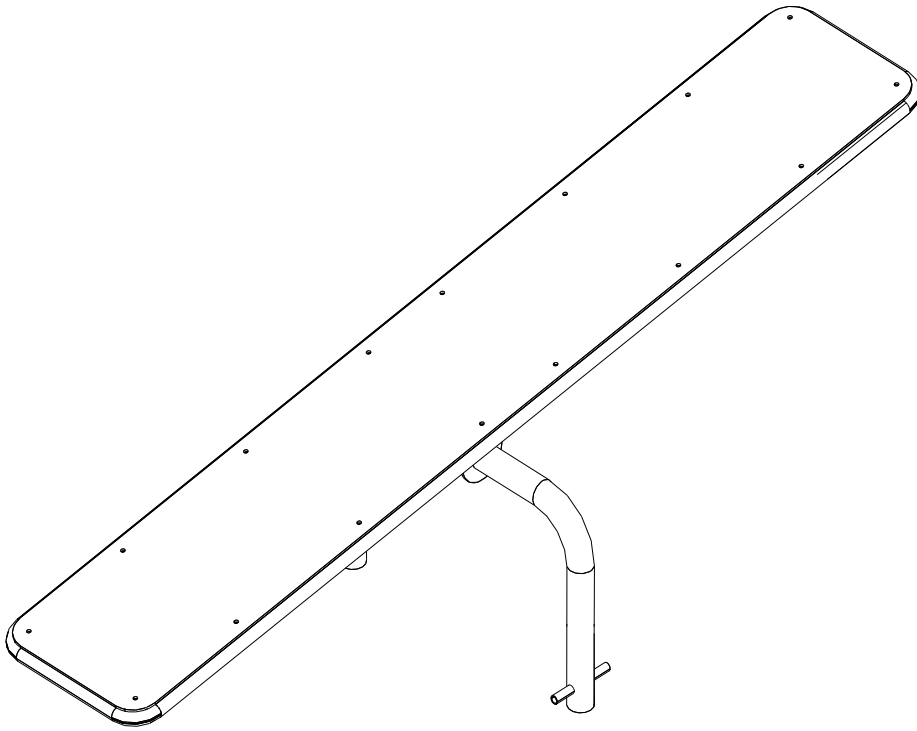
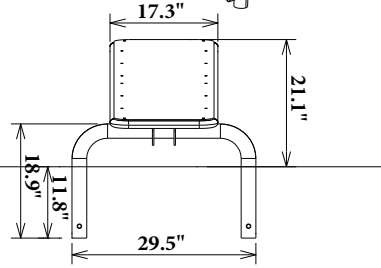
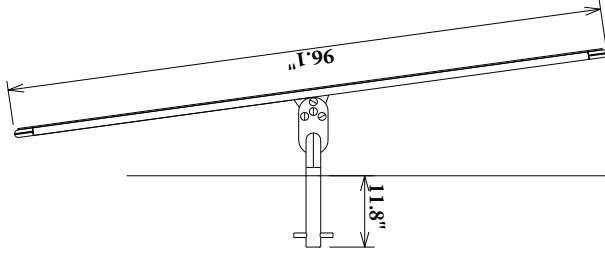
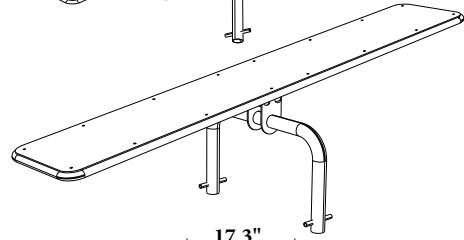
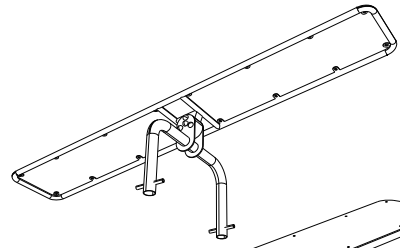
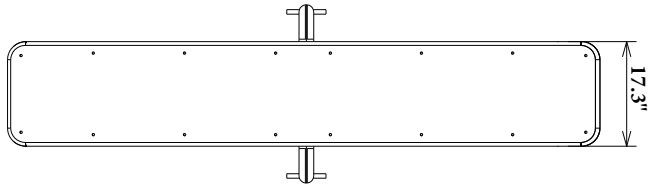

CONCRETE FOOTING